

## PVC CONDUIT FITTINGS & ACCESSORIES



Schedule 40 & 80  
PVC Conduit  
Fittings

Spacers

DB & EB Duct  
Fittings

Telephone Duct  
Fittings

PVC Cement

Split Duct

## Table of Contents

<b>Products, Markets, &amp; Customer Service</b> .....	<b>2</b>
<b>Conduit Products</b> .....	<b>3</b>
<b>Elbows &amp; Sweeps</b> .....	<b>4</b>
<b>Schedule 40 &amp; 80 PVC Conduit Fittings</b>	
Standard Couplings .....	<b>5</b>
Female Adapters .....	<b>5</b>
Terminal Adapters .....	<b>5</b>
Miscellaneous Couplings .....	<b>6</b>
Expansion Couplings .....	<b>7</b>
Reducers .....	<b>7</b>
Box Adapters .....	<b>8</b>
Pipe Caps .....	<b>8</b>
Conduit Clamps .....	<b>8</b>
Plugs .....	<b>8</b>
Offsets .....	<b>8</b>
End Bells .....	<b>9</b>
Junction Boxes .....	<b>9</b>
Meter Risers .....	<b>10</b>
Pull Elbows .....	<b>10</b>
Service Entrance Caps .....	<b>10</b>
Washers .....	<b>10</b>
Swedged Adapter .....	<b>10</b>
<b>Access Fittings</b> .....	<b>11</b>
<b>Switch Boxes</b> .....	<b>12</b>
<b>Slip Meter Risers</b> .....	<b>13</b>
<b>Spacers</b> .....	<b>14</b>
<b>DB &amp; EB Duct Fittings</b> .....	<b>16</b>
<b>Telephone Duct Fittings</b> .....	<b>17</b>
<b>William H. Harvey PVC Cement</b> .....	<b>18</b>
<b>Conduit Installation Instructions – Cementing Joints</b> .....	<b>19</b>
<b>Split Duct</b> .....	<b>20</b>
<b>Split Kits</b> .....	<b>22</b>

\*\*List prices subject to change without notice. Contact your Customer Sales Representative for additional information.

## Products, Markets, and Customer Service

Prime Conduit, Inc. manufactures superior conduit products for the electrical, telecommunications and power utility markets.

### Product Lines & Markets Served:

- Bore-Gard – Electrical and Datacom
- Intra-Gard – Telecommunications
- Multi-Gard – Power Utility and Telecommunications
- P&C Duct – Power and Communications
- PV Mold – Power Utility and Telecommunications
- Schedule 40 & 80 Conduit\* – Electrical and Utility
- Split Duct – Electrical and Telephony
- Telephone Duct – Telephony
- Sweeps and Elbows
- Conduit Fittings and Accessories

### Customer Service & Satisfaction:

Call 1-800-321-1940 for questions regarding sales order, shipping, or delivery. Visit [www.primeconduit.com](http://www.primeconduit.com) for product information, brochures, FAQs, and specifications. eConnect is a web site designed for channel partners that provides real-time, secured access to our Enterprise Business System for Prime Conduit products. eConnect provides the ability to check on order status, price and availability, and search on quotes and contracts. If you wish to become a registered user of eConnect, go to <http://link.primeconduit.com/> and choose **Register now** and we will contact you with your Account information.

**Prime Conduit** has 4 state of the art manufacturing facilities and 3 warehouses strategically located across the United States in order to service the customer with the best, possible delivery time and shipping rates.

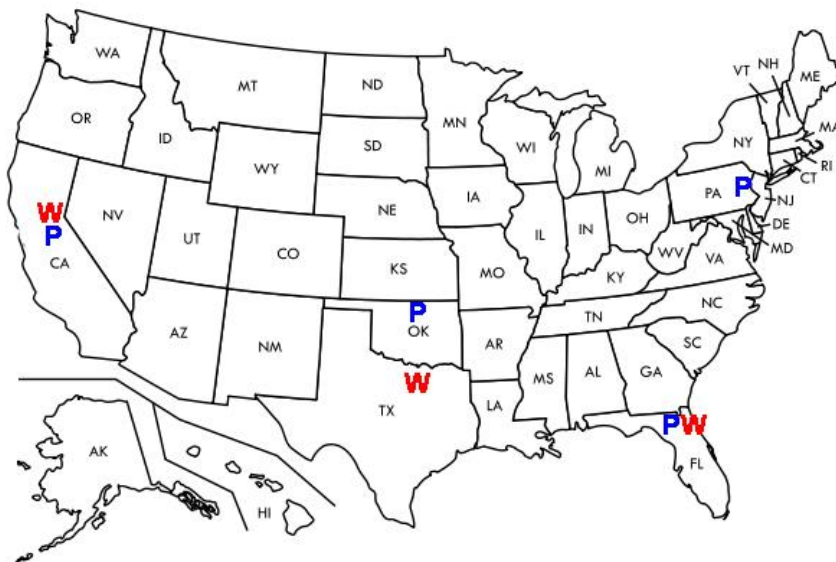

## Conduit Products

Product	Specification																																																	
 Schedule 40 PVC Heavy Wall EPC	ETL Certified to UL651, NEMA TC-2, Federal Specification WC1094A 1/2", 3/4", 1", 1 1/4", 1 1/2", 2, 2 1/2", 3", 3 1/2", 4", 5", 6" Concrete encased & direct burial underground applications; exposed or concealed applications aboveground Rated for use with 90° C conductors																																																	
 Schedule 80 PVC Extra Heavy Wall EPC	ETL Certified to UL651, NEMA TC-2, Federal Specification WC1094A 1/2", 3/4", 1", 1 1/4", 1 1/2", 2, 2 1/2", 3", 4", 5", 6" Listed for aboveground & belowground applications including areas subject o physical damage [352.12 (C)] Rated for use with 90° C conductors																																																	
 Schedule 40 PVC Heavy Wall EPC	Meets CSA Standard C22.2 No.211.1, 3/4" – 4" are FT-4 Rated 1/2", 3/4", 1", 1 1/4", 1 1/2", 2, 2 1/2", 3", 3 1/2", 4", 5", 6" Concrete encased & direct burial underground applications; exposed or concealed applications aboveground Rated for use with 75° C conductors																																																	
 Schedule 40 Heavy Wall PVC Utility	Non-UL Listed, Designed for power utility applications 1 1/2", 2, 2 1/2", 3", 4", 5", 6", 8" Concrete encased, direct burial, power utility applications Rated for use with 90° C conductors or cable																																																	
 Telephone Duct	NEMA TC-10 & Bellcore CA08546 (Types B and C) 4" PVC: Type B & Type B Heavy Wall, Type C, Type C Tel-Gard, Type D Concrete encased (Types B & C), Direct Bury (Type C), Exposed Applications (Type D)																																																	
 P&C Duct	<table border="1"> <thead> <tr> <th>Type</th> <th>90° Cable</th> <th>Size</th> <th>TC 6 &amp; 8</th> <th>ASTM F-512</th> <th>Concrete Encased</th> <th>Direct Burial</th> </tr> </thead> <tbody> <tr> <td>*EB-20</td> <td>√</td> <td>2", 3", 4", 5", 6"</td> <td>√</td> <td>√</td> <td>√</td> <td></td> </tr> <tr> <td>EB-35 Heavy Wall</td> <td>√</td> <td>2", 3", 4", 5", 6"</td> <td>√</td> <td>√</td> <td>√</td> <td></td> </tr> <tr> <td>DB-60</td> <td>√</td> <td>2", 3", 3 1/2", 4", 5", 6"</td> <td>√</td> <td>√</td> <td>√</td> <td>√</td> </tr> <tr> <td>DB-120 Heavy Wall</td> <td>√</td> <td>1, 1 1/2", 2", 3", 4", 5", 6"</td> <td>√</td> <td>√</td> <td>√</td> <td>√</td> </tr> <tr> <td>DB-100</td> <td>√</td> <td>4", 5", 6"</td> <td>√</td> <td>√</td> <td>√</td> <td>√</td> </tr> <tr> <td>DB-100 DWP</td> <td>√</td> <td>3", 4", 5"</td> <td>√</td> <td>√</td> <td>√</td> <td>√</td> </tr> </tbody> </table>	Type	90° Cable	Size	TC 6 & 8	ASTM F-512	Concrete Encased	Direct Burial	*EB-20	√	2", 3", 4", 5", 6"	√	√	√		EB-35 Heavy Wall	√	2", 3", 4", 5", 6"	√	√	√		DB-60	√	2", 3", 3 1/2", 4", 5", 6"	√	√	√	√	DB-120 Heavy Wall	√	1, 1 1/2", 2", 3", 4", 5", 6"	√	√	√	√	DB-100	√	4", 5", 6"	√	√	√	√	DB-100 DWP	√	3", 4", 5"	√	√	√	√
	Type	90° Cable	Size	TC 6 & 8	ASTM F-512	Concrete Encased	Direct Burial																																											
	*EB-20	√	2", 3", 4", 5", 6"	√	√	√																																												
	EB-35 Heavy Wall	√	2", 3", 4", 5", 6"	√	√	√																																												
	DB-60	√	2", 3", 3 1/2", 4", 5", 6"	√	√	√	√																																											
	DB-120 Heavy Wall	√	1, 1 1/2", 2", 3", 4", 5", 6"	√	√	√	√																																											
	DB-100	√	4", 5", 6"	√	√	√	√																																											
DB-100 DWP	√	3", 4", 5"	√	√	√	√																																												
*EB-20 is ETL Certified to UL651A																																																		
 Multi-Gard	<table border="1"> <thead> <tr> <th>Material</th> <th>Application</th> <th>Type</th> <th>Size</th> <th>Approvals</th> </tr> </thead> <tbody> <tr> <td>PVC</td> <td>Outdoor - Direct Bury, Concrete Encased</td> <td>Type C, Type 40, Type 80</td> <td>3-Way 1-1/2", 4-Way 1-1/4"</td> <td>UL Listed, ETL Certified to UL651</td> </tr> <tr> <td>Fiberglass</td> <td>Outdoor (UV Resistant) - Bridge Crossings, Areas Subject to Physical Damage (Bullet-Proof)</td> <td>Heavy or Bullet Resistant</td> <td>3-Way 1-1/2", 4-Way 1-1/4"</td> <td></td> </tr> <tr> <td>Steel</td> <td>Outdoor - Bridge Crossings, Areas Subject to Physical Damage (Vandalism &amp; Crush)</td> <td>Galvanized or PVC Coated Steel</td> <td>3-Way 1-1/2", 4-Way 1-1/4"</td> <td>Conforms to NEC Article 300.22 and NFPA 90A for installation of communication cables inside buildings</td> </tr> <tr> <td>EMT</td> <td>Indoor - Inside Buildings</td> <td>EMT</td> <td>3-Way 1-1/2", 4-Way 1-1/4"</td> <td>UL Listed EMT Outer Shell, Conforms to NFPA 90A for installation of communication cables inside buildings</td> </tr> </tbody> </table>	Material	Application	Type	Size	Approvals	PVC	Outdoor - Direct Bury, Concrete Encased	Type C, Type 40, Type 80	3-Way 1-1/2", 4-Way 1-1/4"	UL Listed, ETL Certified to UL651	Fiberglass	Outdoor (UV Resistant) - Bridge Crossings, Areas Subject to Physical Damage (Bullet-Proof)	Heavy or Bullet Resistant	3-Way 1-1/2", 4-Way 1-1/4"		Steel	Outdoor - Bridge Crossings, Areas Subject to Physical Damage (Vandalism & Crush)	Galvanized or PVC Coated Steel	3-Way 1-1/2", 4-Way 1-1/4"	Conforms to NEC Article 300.22 and NFPA 90A for installation of communication cables inside buildings	EMT	Indoor - Inside Buildings	EMT	3-Way 1-1/2", 4-Way 1-1/4"	UL Listed EMT Outer Shell, Conforms to NFPA 90A for installation of communication cables inside buildings																								
	Material	Application	Type	Size	Approvals																																													
	PVC	Outdoor - Direct Bury, Concrete Encased	Type C, Type 40, Type 80	3-Way 1-1/2", 4-Way 1-1/4"	UL Listed, ETL Certified to UL651																																													
	Fiberglass	Outdoor (UV Resistant) - Bridge Crossings, Areas Subject to Physical Damage (Bullet-Proof)	Heavy or Bullet Resistant	3-Way 1-1/2", 4-Way 1-1/4"																																														
	Steel	Outdoor - Bridge Crossings, Areas Subject to Physical Damage (Vandalism & Crush)	Galvanized or PVC Coated Steel	3-Way 1-1/2", 4-Way 1-1/4"	Conforms to NEC Article 300.22 and NFPA 90A for installation of communication cables inside buildings																																													
EMT	Indoor - Inside Buildings	EMT	3-Way 1-1/2", 4-Way 1-1/4"	UL Listed EMT Outer Shell, Conforms to NFPA 90A for installation of communication cables inside buildings																																														
Boreable	Outdoor - Horizontal Directional Drilled	Type 40 PVC Outer Duct	3-Way 1-1/2", 4-Way 1-1/4"	Minimum Crush per CSA C22.2 No.211.2, UL 651 & NEMA TC-2																																														
 Intra-Gard	Bellcore GR-356 Core Schedule 40 & Type C: 1-1/4", 1-1/2", 2" 4-Way, 6-Way, and 4-Way Hybrid Direct bury & concrete encased applications																																																	
 Bore-Gard Trenchless Raceway	ETL Certified to UL651, CSA Certified (Schedule 40) 2", 3", 4", 5", 6" & 8" Horizontal directional drilling for electrical and datacom applications																																																	
 PV Mold	Exceeds NESC requirements, Designed in accordance with NEMA TC-19 Standard Duty: 1, 2", 3", 4", 5" Heavy Duty Schedule 40: 1 1/2", 2", 3", 4", 5", 6" Extra Heavy Duty Schedule 80: 2" – 3" Pole riser system designed to protect communications power cable installed on poles																																																	
 Split Duct & Kits	Schedule 40 Duct & Kits: 2", 2 1/2", 3", 3 1/2", 4", 5", 6"; Schedule 80 Duct: 2", 4"; C Duct & Kits: 4" Repair broken ductwork																																																	

## Elbows and Sweeps

Prime Conduit Elbows and Sweeps Part Numbering System					
Position:	1	2	3	4	5
Letter/Number:	UA	7	A	K	
Description:	Sch. 40	45°	Std. Radius	2 1/2"	Non-Belled

### 1: Product Line

- UA = Schedule 40 Heavy Wall EPC
- UB = Schedule 80 Extra Heavy Wall EPC
- UC = Schedule 40 Heavy Wall Utility Conduit\*
- PE = DB-100 Sweeps\*
- PF = DB-60 Sweeps\*
- PH = DB-120 Sweeps\*
- TP = Telephone Duct "C" Sweeps\*
- TW = White Telephone Duct "C" Sweeps\*



\* Non-ETL Listed

### 2: Angle

- 9 = 90° Elbow
- 7 = 45° Elbow
- 6 = 30° Elbow
- 5 = 22 1/2° Elbow
- 3 = 11 1/4° Elbow

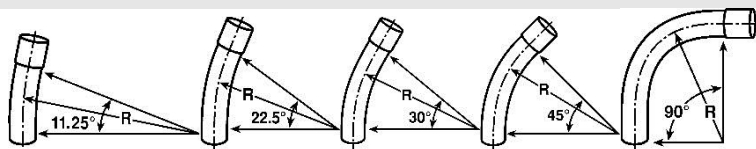

### 3: Radius

- A = Standard Radius
- B = 12"
- C = 18"
- D = 24"
- E = 30"
- F = 36"
- H = 48"
- I = 60"
- J = 72"
- N = 120"
- R = 144"
- S = 150"
- T = 180"
- U = 240"
- V = 300"

### Standard Radius Elbow Dimensions

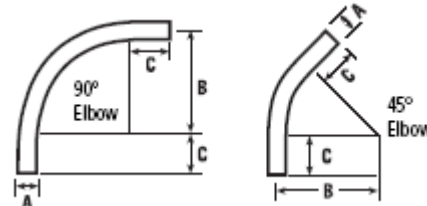

Size	A	B Min. (Radius)	C Min.
1/2"	0.840	4"	1 1/2"
3/4"	1.050	4 1/2"	1 1/2"
1"	1.315	5 3/4"	2"
1 1/4"	1.660	7 1/4"	2"
1 1/2"	1.900	8 1/4"	2"
2"	2.375	9 1/2"	2"
2 1/2"	2.875	10 1/2"	3"
3"	3.500	13"	3-1/8"
3 1/2"	4.000	15"	3-1/4"
4"	4.500	16"	3-3/8"
5"	5.563	24"	3-5/8"
6"	6.625	30"	3-3/4"

### 4: Diameter

- D = 1/2"
- E = 3/4"
- F = 1"
- G = 1 1/4"
- H = 1 1/2"
- J = 2"
- K = 2 1/2"
- L = 3"
- M = 3 1/2"
- N = 4"
- P = 5"
- R = 6"
- T = 8"



### 5: Belled Elbow

- B = Belled; All DB-100, DB-60, DB-120, and Telephone Duct sweeps are belled and do not have the "B" in position 5.
- S = Segmented





## Schedule 40 & 80 PVC Conduit Fittings

### Standard Couplings



Part Number	Size	EACH UPC	Carton Quantity
CP050	1/2"	670648007978	200
CP075	3/4"	670648007985	125
CP100	1"	670648007992	70
CP125	1-1/4"	670648008005	40
CP150	1-1/2"	670648008012	30
CP200	2"	670648008036	40
CP250	2-1/2"	670648008043	20
CP300	3"	670648008050	40
CP350	3-1/2"	670648008067	30
CP400	4"	670648008074	20
CP500	5"	670648008081	10
CP600	6"	670648008098	8

Price Group: A1

### Female Adapters



Part Number	Size	EACH UPC	Carton Quantity
FA050	1/2"	670648008104	200
FA075	3/4"	670648008111	125
FA100	1"	670648008128	70
FA125	1-1/4"	670648008135	40
FA150	1-1/2"	670648008142	30
FA200	2"	670648008159	40
FA250	2-1/2"	670648008166	20
FA300	3"	670648008173	40
FA350	3-1/2"	670648008180	30
FA400	4"	670648008197	20
FA500	5"	670648008203	10
FA600	6"	670648008210	8

Price Group: A2

### Special Long Line Female Adapter \*non-UL Listed Price Group: F6

Part Number	Size	EACH UPC	Carton Quantity
*FA600X600	6" x 6" Long	670648356311	6

### Terminal Adapters



Part Number	Size	EACH UPC	Carton Quantity
TA050	1/2"	670648008227	200
TA075	3/4"	670648008234	125
TA100	1"	670648008241	70
TA125	1-1/4"	670648008258	40
TA150	1-1/2"	670648008265	30
TA200	2"	670648008272	40
TA250	2-1/2"	670648008289	20
TA300	3"	670648008296	40
TA350	3-1/2"	670648008302	30
TA400	4"	670648008319	20
TA500	5"	670648008326	10
TA600	6"	670648008333	8

Price Group: A3

## Schedule 40 & 80 PVC Conduit Fittings - Couplings

Sch. 40 Long Line Coupling with Center Stop



Price Group: G1

Part Number	Size	UPC Number	Carton Quantity	Diameter x Length
CPL LCS200X4125	2"	670648014129	100	2" X 4-1/8"
CPL LCS250X5125	2-1/2"	670648014136	30	2-1/2" X 5-1/8"
CPL LCS300X6125	3"	670648014143	30	3" X 6-1/8"
CPL LCS400X7125	4"	670648014150	20	4" X 7-1/8"
CPL LCS500X9125	5"	670648014167	10	5" X 9-1/8"
CPL LCS600X10125	6"	670648014174	6	6" X 10-1/8"

Sch. 40 Repair Coupling - No Internal Center Stop

(Also known as a Sleeve Coupling)



Price Group: G2

Part Number	Size	UPC Number	Carton Quantity	Diameter x Length
CPRPR150X400	1-1/2"	670648000122	25	1-1/2" X 4"
CPLLRPR150X4875	1-1/2"	670648001884	25	1-1/2" X 4-7/8"
CPRPR150X2400	1-1/2"	670648000115	25	1-1/2" X 24"
CPRPR200X300	2"	670648000153	25	2" X 3"
CPRPR200X600	2"	670648006186	25	2" X 6"
CPRPR250X600	2-1/2"	670648000177	25	2-1/2" X 6"
CPRPR300X400	3"	670648000191	25	3" X 4"
CPRPR300X600	3"	670648006193	25	3" X 6"
CPRPR300X1200	3"	670648000184	8	3" X 12"
CPRPR400X650	4"	670648006209	15	4" X 6-1/2"
CPRPR400X700	4"	670648000238	15	4" X 7"
CPRPR400X1200	4"	670648000214	10	4" X 12"
CPRPR500X700	5"	670648006216	8	5" X 7"
CPRPR500X1000	5"	670648000245	7	5" X 10"
CPRPR600X600	6"	670648000269	6	6" X 6"
CPRPR600X1000	6"	670648006223	4	6" X 10"
CPRPR600X1200	6"	670648000252	6	6" X 12"
CPSLP250X300	2-1/2"	670648000344	50	2-1/2" X 3"

Schedule 40 Slip Coupling

Repair Coupling - Schedule 40 Split Duct



Price Group: G3

Part Number	Size	UPC Number	Carton Quantity	Diameter x Length
CPRPRSD200X300	2"	670648000276	25	2" X 3"
CPRPRSD250X700	2-1/2"	670648000283	25	2-1/2" X 7"
CPRPRSD300X400	3"	670648000306	25	3" X 4"
CPRPRSD400X650	4"	670648000320	10	4" X 6-1/2"
CPRPRSD500X700	5"	670648000337	14	5" X 7"

Schedule 40 Split Sleeve Coupling



CPSPLT1S – split 1 side  
CPSPLT2S – split 2 sides

Price Group: U2

Part Number	Size	UPC Number	Carton Quantity	Diameter x Length
CPSPLT1S200X600	2"	670648000351	25	2" X 6"
CPSPLT1S250X700	2-1/2"	670648000368	25	2-1/2" X 7"
CPSPLT1S300X700	3"	670648000375	25	3" X 7"
CPSPLT1S350X800	3-1/2"	670648000511	25	3-1/2" X 8"
CPSPLT1S400X800	4"	670648000399	15	4" X 8"
CPSPLT1S500X400	5"	670648000443	30	5" X 4"
CPSPLT1S500X800	5"	670648000450	15	5" X 8"
CPSPLT1S500X900	5"	670648000467	8	5" X 9"
CPSPLT1S600X1000	6"	670648000474	4	6" X 10"
CPSPLT2S300X650	3"	670648000481	25	3" X 6-1/2"
CPSPLT2S400X600	4"	670648000993	25	4" X 6"

## Schedule 40 & 80 Conduit Fittings

### Expansion Coupling - One Piece



Price Group: G5

Part Number	Size	EACH UPC	Carton Quantity	Travel Length
EC1PC075	3/4"	670648011173	50	4"
EC1PC100	1"	670648011180	50	5"
EC1PC125	1-1/4"	670648011197	25	5"
EC1PC150	1-1/2"	670648011203	25	5"
EC1PC200	2"	670648011210	25	6"

### Expansion Coupling - Two Piece

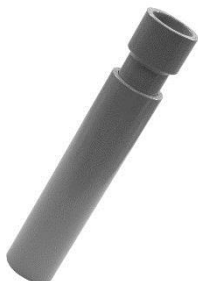

Price Group: G4

Part Number	Size	EACH UPC	Carton Quantity	Expansion
EC2PC050	1/2"	670648011289	25	4"
EC2PC075	3/4"	670648011296	10	4"
EC2PC100	1"	670648011302	10	4"
EC2PC125	1-1/4"	670648011326	5	4"
EC2PC150	1-1/2"	670648011357	5	4"
EC2PC200	2"	670648011364	25	4"
EC2PC250	2-1/2"	670648011371	12	7.25"
EC2PC300	3"	670648011395	12	7.25"
EC2PC350	3-1/2"	670648011401	6	8"
EC2PC400	4"	670648011418	6	8"
EC2PC500	5"	670648011425	1	8"
EC2PC600	6"	670648011432	1	8"

### Swedge Reducer Spigot x Spigot



Price Group: F5

Part Number	Size	EACH UPC	Carton Quantity
RSSS250X200	2-1/2" X 2"	670648001808	20
RSSS300X200	3" X 2"	670648001815	25
RSSS300X250	3" X 2-1/2"	670648001822	25
RSSS400X300	4" X 3"	670648001839	15
RSSS400X350	4" X 3-1/2"	670648001846	20
RSSS500X400	5" X 4"	670648001853	8
RSSS600X500	6" X 5"	670648001860	4

### Reducer Bushings

(Used in connecting different sizes of conduit.)



Price Group: F4

Part Number	Size	EACH UPC	Carton Quantity
RB075X050	3/4" X 1/2"	670648011050	100
RB100X075	1" X 3/4"	670648011067	100
RB125X075	1-1/4" X 3/4"	670648011074	50
RB125X100	1-1/4" X 1"	670648011081	50
RB150X125	1-1/2" X 1-1/4"	670648011104	50
RB200X125	2" X 1-1/4"	670648011111	25
RB200X150	2" X 1-1/2"	670648011128	25
RB250X200	2-1/2" X 2"	670648011135	25
RB300X200	3" X 2"	670648011142	25
RB300X250	3" X 2-1/2"	670648011159	25
RB400X300	4" X 3"	670648011166	20



## Schedule 40 & 80 Conduit Fittings

### Box Adapters



Price Group: F1

Part Number	Size	EACH UPC	Carton Quantity
BA050	1/2"	670648007800	100
BA075	3/4"	670648007817	100
BA100	1"	670648007824	100
BA125	1-1/4"	670648007831	50
BA150	1-1/2"	670648007848	50
BA200	2"	670648007855	25
BA250	2-1/2"	670648007862	10
BA300	3"	670648007879	10
BA400	4"	670648007886	10

### Pipe Caps



Price Group: H2

Part Number	Size	EACH UPC	Carton Quantity
CAP050	1/2"	670648135930	100
CAP075	3/4"	670648135947	100
CAP100	1"	670648135954	100
CAP125	1-1/4"	670648135961	100
CAP150	1-1/2"	670648135978	100
CAP200	2"	670648135985	100
CAP250	2-1/2"	670648135992	60
CAP300	3"	670648136005	60
CAP400	4"	670648136012	30
CAP500	5"	670648136029	15
CAP600	6"	670648136036	10

### Conduit Clamps



Price Group: K1

Part Number	Size	EACH UPC	Carton Quantity
CLMP050	1/2"	670648007893	300
CLMP075	3/4"	670648007909	200
CLMP100	1"	670648007916	200
CLMP125	1-1/4"	670648007923	200
CLMP150	1-1/2"	670648007930	200
CLMP200	2"	670648007947	200
CLMP250	2-1/2"	670648007954	100
CLMP300	3"	670648007961	100

### Polyethylene Plugs with Tabs



Price Group: F6

Part Number	Size	EACH UPC	Carton Quantity
PEPT200	2"	670648136043	100
PEPT300	3"	670648136050	80
PEPT400	4"	670648136067	50
PEPT500	5"	670648136074	40
PEPT600	6"	670648136081	30

### Offsets



Price Group: F6

Part Number	Size	EACH UPC	Carton Quantity
PVCSET050	1/2"	670648011012	25
PVCSET075	3/4"	670648011029	25

## Schedule 40 & 80 Conduit Fittings

### Meter Offset



Part Number	Size	EACH UPC	Carton Quantity
MTRSET125	1-1/4"	670648011036	15
MTRSET200	2"	670648011043	8

### End Bells



Part Number	Size	EACH UPC	Carton Quantity
EB100	1"	670648010893	50
EB125	1-1/4"	670648010909	50
EB150	1-1/2"	670648010916	50
EB200	2"	670648010923	40
EB250	2-1/2"	670648010930	30
EB300	3"	670648010947	50
EB350	3-1/2"	670648010954	50
EB400	4"	670648010961	50
EB500	5"	670648010978	25
EB600	6"	670648010985	15

### Fabricated End Bells



Part Number	Size	EACH UPC	Carton Quantity
EB200X400	2" x 4"	670648356304	25
EB200X500	2" x 5"	670648083569	50
EB200X600	2" X 6"	670648006230	50
EB200X800	2" x 8"	670648083576	12
EB300X600	3" X 6"	670648006247	25
EB400X500	4" X 5"	670648005950	20
EB400X600	4" x 6"	670648083583	15
EB600X500	6" x 5"	670648000641	12
EB600X800	6" x 8"	670648000634	6

### Junction Boxes



Part Number	Size	EACH UPC	Carton Quantity
JB6P442	4"X4"X2"	670648010282	10
JB6P444	4"X4"X4"	670648010251	10
JB6P446	4"X4"X6"	670648010299	10
JB6P552	5"X5"X2"	670648010305	10
JB6P664	6"X6"X4"	670648010268	10
JB6P666	6"X6"X6"	670648010312	5
JB6P884	8"X8"X4"	670648010275	5
JB6P887	8"X8"X7"	670648010787	4
JB6P12124	12" X 12" X 4"	670648010794	2
JB6P12126	12" X 12" X 6"	670648010770	2

## Schedule 40 & 80 Conduit Fittings

### Schedule 40 and Schedule 80 Meter Risers



Price Group: X1

Part Number	Size	EACH UPC	Crate Quantity
MRS40150X8000	Sch 40; 1-1/2" X 80" L	670648148312	180
MRS40200X6000	Sch 40; 2" X 60" L	670648005967	140
MRS40200X8000	Sch 40; 2" X 80" L	670648148329	140
MRS40250X3600	Sch 40; 2-1/2" X 36" L	670648148336	93
MRS40250X6000	Sch 40; 2-1/2" X 60" L	670648006131	93
MRS40250X8000	Sch 40; 2-1/2" X 80" L	670648148343	94
MRS40300X6000	Sch 40; 3" X 60" L	670648005974	88
MRS40300X8000	Sch 40; 3" X 80" L	670648148350	75
MRS80200X8400	Sch 80; 2" X 84" L	670648002003	140
MRS80250X8400	Sch 80; 2-1/2" X 84" L	670648148374	94
MRS80250X12000	Sch 80; 2-1/2" X 120" L	670648148367	140

### Pull Elbows

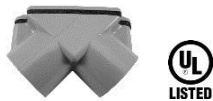

Price Group: F6

Part Number	Size	EACH UPC	Carton Quantity
PELB050	1/2"	670648010992	75
PELB075	3/4"	670648011005	50

### Service Entrance Caps



Price Group: H1

Part Number	Size	EACH UPC	Carton Quantity
SEC050	1/2"	670648010800	10
SEC075	3/4"	670648010817	10
SEC100	1"	670648010824	20
SEC125	1-1/4"	670648010831	20
SEC150	1-1/2"	670648010848	20
SEC200	2"	670648010855	5
SEC250	2-1/2"	670648010862	5
SEC300	3"	670648010879	5
SEC400	4"	670648010886	1

### Washers



Price Group: F6

Part Number	Size	EACH UPC	Carton Quantity
WSR050	1/2"	670648011227	150
WSR075	3/4"	670648011234	125
WSR100	1"	670648011241	100
WSR125	1-1/4"	670648011258	50
WSR150	1-1/2"	670648011265	25
WSR200	2"	670648011272	50

### Swedged Adapter



Price Group: F5

Part Number	Size	EACH UPC	Carton Quantity
ASPHSXB600X700	6" PVC Male to 7" HDPE Female	670648005882	4

## Schedule 40 & 80 PVC Access Fittings

Price Group: J1

### Type T



Part Number	Size	EACH UPC	Carton Quantity	Volume (in <sup>3</sup> )
AFT050	1/2"	670648007725	25	3.8
AFT075	3/4"	670648007732	15	7.8
AFT100	1"	670648007749	10	12.3
AFT125	1-1/4"	670648007756	10	27.5
AFT150	1-1/2"	670648007763	10	37.8
AFT200	2"	670648007770	5	69.5

### Type LL



Part Number	Size	EACH UPC	Carton Quantity	Volume (in <sup>3</sup> )
AFL050	1/2"	670648007602	25	4.3
AFL075	3/4"	670648007619	15	7.8
AFL100	1"	670648007626	10	12.3
AFL125	1-1/4"	670648007633	10	27.5
AFL150	1-1/2"	670648007640	10	37.8
AFL200	2"	670648007657	5	69.5

### Type LR



Part Number	Size	EACH UPC	Carton Quantity	Volume (in <sup>3</sup> )
AFLR050	1/2"	670648007664	25	3.8
AFLR075	3/4"	670648007671	15	7.8
AFLR100	1"	670648007688	10	12.3
AFLR125	1-1/4"	670648007695	10	27.5
AFLR150	1-1/2"	670648007701	10	37.8
AFLR200	2"	670648007718	5	69.5

### Type LB



Part Number	Size	EACH UPC	Carton Quantity	Volume (in <sup>3</sup> )
AFLB050	1/2"	670648007503	25	4.3
AFLB075	3/4"	670648007510	15	7.8
AFLB100	1"	670648007527	10	11.8
AFLB125	1-1/4"	670648007534	10	27.5
AFLB150	1-1/2"	670648007541	10	37.8
AFLB200	2"	670648007558	5	69.5
AFLB250	2-1/2"	670648007565	5	188
AFLB300	3"	670648007572	5	188
AFLB350	3-1/2"	670648007589	4	324
AFLB400	4"	670648007596	4	324

### TYPE C



Part Number	Size	EACH UPC	Carton Quantity	Volume (in <sup>3</sup> )
AFC050	1/2"	670648007404	25	3.8
AFC075	3/4"	670648007411	15	7.8
AFC100	1"	670648007428	10	12.3
AFC125	1-1/4"	670648007435	10	27.5
AFC150	1-1/2"	670648007442	10	37.8
AFC200	2"	670648007459	5	69.5

### TYPE E



Part Number	Size	EACH UPC	Carton Quantity	Volume (in <sup>3</sup> )
AFE050	1/2"	670648007466	25	3.8
AFE075	3/4"	670648007473	15	7.8
AFE100	1"	670648007480	10	12.3
AFE200	2"	670648007497	5	69.5

### TYPE X



Part Number	Size	EACH UPC	Carton Quantity	Volume (in <sup>3</sup> )
AFX050	1/2"	670648007787	15	15.8
AFX075	3/4"	670648007794	15	15.8

## Schedule 40 & 80 PVC Switch Boxes

Price Group: C1



**1-Gang FSCC**

Part Number	Size	EACH UPC	Carton Quantity
FSCC1G050	1/2"	670648144819	10
FSCC1G075	3/4"	670648144826	10
FSCC1G100	1"	670648144833	10



**1-Gang FDE**

Part Number	Size	EACH UPC	Carton Quantity
FDE1G050	1/2"	670648144857	10
FDE1G075	3/4"	670648144864	10
FDE1G100	1"	670648144871	10



**1-Gang FSE**

Part Number	Size	EACH UPC	Carton Quantity
FSE1G050	1/2"	670648144932	10
FSE1G075	3/4"	670648144949	10
FSE1G100	1"	670648144956	10



**1-Gang FDC**

Part Number	Size	EACH UPC	Carton Quantity
FDC1G050	1/2"	670648144963	10
FDC1G075	3/4"	670648144970	10
FDC1G100	1"	670648144987	10



**1-Gang FSC**

Part Number	Size	EACH UPC	Carton Quantity
FSC1G050	1/2"	670648145021	10
FSC1G075	3/4"	670648145038	10
FSC1G100	1"	670648010213	10



**1-Gang FSS**

Part Number	Size	EACH UPC	Carton Quantity
FSS1G050	1/2"	670648010220	10
FSS1G075	3/4"	670648010237	10
FSS1G100	1"	670648010244	10



**2-Gang FSC**

Part Number	Size	EACH UPC	Carton Quantity
FSC2G050	1/2"	670648144994	5
FSC2G075	3/4"	670648145007	5
FSC2G100	1"	670648145014	5



**2-Gang FSE**

Part Number	Size	EACH UPC	Carton Quantity
FSE2G050	1/2"	670648144895	5
FSE2G075	3/4"	670648144901	5
FSE2G100	1"	670648144918	5



**1-Gang FD**

Part Number	Gang	EACH UPC	Carton Quantity
FDBLNK1G	1	670648144840	10



**Covers**

Price Group: D2

Part Number	Gang	EACH UPC	Carton Quantity
FSCVR1G	1	670648144925	50
FSCVR2G	2	670648144888	25



## Slip Meter Risers

Slip Meter Risers	Part Number	Size	EACH UPC	Carton Quantity
Price Group: X1	SMR200X2400	2" x 24"	670648339147	20
	SMR250X2400	2-1/2" x 24"	670648338126	1
	SMR300X2400	3" x 24"	670648337945	10
	SMR400X2400	4" x 24"	670648160963	10
	SMR200X2400S	2" x 24" Split	670648194364	10
	SMR300X2400S	3" x 24" Split	670648194371	5

Part Number	Thread Size	B (min.) in.	Mating PVC Pipe Size & Type
SMR200X2400	2" NPT	2.492	2" Sch 40 Conduit (Ref. O.D. 2.375")
SMR200X2400S	2" NPT	2.492	2" Sch 40 Conduit (Ref. O.D. 2.375")
SMR250X2400	2-1/2" NPSC	2.961	2-1/2" Sch 40 Conduit (Ref. O.D. 2.875")
SMR300X2400	3" NPSC	3.616	3" Sch 40 Conduit (Ref. O.D. 3.500")
SMR300X2400S	3" NPSC	3.616	3" Sch 40 Conduit (Ref. O.D. 3.500")
SMR400X2400	4" NPSC	4.859	4" Sch 40 Conduit (Ref. O.D. 4.500")

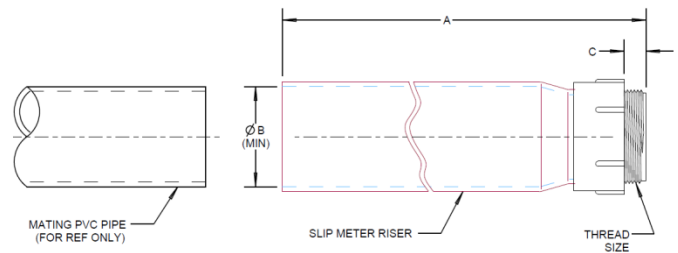

Slip Meter Risers are designed for use in electrical service entrance applications. They provide solutions for applications requiring a non-rigid connection, with incoming service conduit diameters ranging from 2" to 4". The Slip Meter Risers are fitted with a terminal adapter for easy installation at the service entrance location, and provide a low-cost method to comply with NEC 300-5 (j), which requires protection for buried cables in areas subject to ground movement due to frost or trench settling.

### Features

- Designed to provide faster and easier underground service entrance installations.
- Provides cable protection from ground movement.
- Accommodates incoming service conduit diameters ranging from 2" to 4".
- Fitted with Terminal Adapters for easy installing.
- Complies with NEC 300-5(J)

### NEC Article 300 Wiring Methods

**(J) Earth Movement.** Where direct buried conductors, raceways, or cables are subject to movement by settlement or frost, direct buried conductors, raceways, or cables shall be arranged to prevent damage to the enclosed conductors or to equipment connected to the raceways.

**(Informational Note):** This section recognizes "S" loops in underground direct burial to raceway transitions, expansion joints in raceway risers to fixed equipment, and generally the provision of flexible connections to equipment subject to settlement or frost heaves.



## Intermediate and Base Spacers

Price Group: W1

### Base Spacers

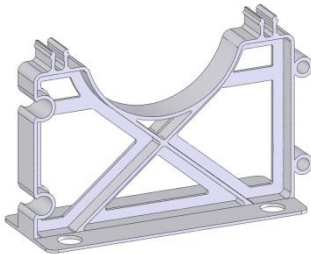

Part Number	Size	EACH UPC	Standard Carton Quantity
SPB200X150	2" X 1-1/2"	670648007008	450
SPB200X200	2" X 2"	670648007015	325
SPB200X300	2" X 3"	670648007022	300
SPB300X150	3" X 1-1/2"	670648007039	250
SPB300X200	3" X 2"	670648007046	225
SPB300X300	3" X 3"	670648007053	190
SPB400X100	4" X 1"	670648007060	250
SPB400X150	4" X 1-1/2"	670648007077	180
SPB400X200	4" X 2"	670648007084	180
SPB400X300	4" X 3"	670648007091	150
SPB500X150	5" X 1-1/2"	670648007114	140
SPB500X200	5" X 2"	670648007121	100
SPB500X300	5" X 3"	670648007206	90
SPB600X150	6" X 1-1/2"	670648007213	100
SPB600X200	6" X 2"	670648007220	100
SPB600X300	6" X 3"	670648007237	90
*SPB800X200	8" X 2"	670648006506	65
*SPB800X300	8" X 3"	670648145700	60

### Intermediate Spacers

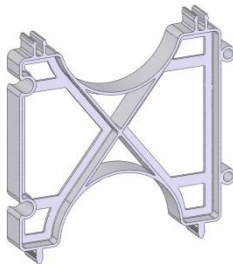

SPL200X150	2" X 1-1/2"	670648007244	500
SPL200X200	2" X 2"	670648007251	325
SPL200X300	2" X 3"	670648007268	275
SPL300X150	3" X 1-1/2"	670648007275	250
SPL300X200	3" X 2"	670648007282	225
SPL300X300	3" X 3"	670648007299	160
SPL400X100	4" X 1"	670648007305	250
SPL400X150	4" X 1-1/2"	670648007312	180
SPL400X200	4" X 2"	670648007329	160
SPL400X300	4" X 3"	670648007336	125
SPL500X150	5" X 1-1/2"	670648007343	140
SPL500X200	5" X 2"	670648007350	100
SPL500X300	5" X 3"	670648007367	90
SPL600X150	6" X 1-1/2"	670648007374	100
SPL600X200	6" X 2"	670648007381	100
SPL600X300	6" X 3"	670648007398	75
*SPL800X200	8" X 2"	670648006513	70
*SPL800X300	8" X 3"	670648145915	45

Resistant to Extreme Temperature Fluctuations • Constructed of High Impact Polymers • Available in 17 Sizes • Snap Locking Design for Fast Field Assembly • Virtually Indestructible • Proven Design • No Banding Required • Ensures Accurate Duct Separation

Prime Conduit's Hi-Impact Utility Duct Spacers utilizes a proven two-piece design specifically engineered to support duct arrays within trenching prior to encasement, these sturdy, versatile and light-weight spacers will not shift under the weight of your workmen to stay firmly in place during fill.

Available in 18 sizes, Prime Conduit's Utility Duct Spacers can accommodate duct work ranging in size from 2 to 8 inches while providing separation of 1.5 to 3 inches. Our spacers are also available in 18 pre-fabricated configurations make them the easiest spacer to install in the field

Molded from the finest grades of high impact polymers using state-of-the-art manufacturing techniques, these products are highly resistant to extreme temperature fluctuations, UV light, are virtually indestructible and offer the consistent lot-to-lot conformity that is a must when accurate duct separation is required.

# Prime Conduit Inc.

Spacer Size	A	B	C	D	E	F	R
2" x 1 1/2"	3.975	4.250	3.985	2.500	3.000	1.500	1.250
2" x 2"	4.460	4.250	4.460	2.500	3.000	1.500	1.250
2" x 3"	5.465	4.255	5.460	2.500	3.000	3.000	1.250
3" x 1 1/2"	5.130	4.810	5.130	3.630	3.000	1.500	1.815
3" x 2"	5.630	4.810	5.630	3.630	3.000	2.000	1.815
3" x 3"	6.630	4.810	6.630	3.630	3.000	3.000	1.815
4" x 1"	5.630	4.060	5.630	4.630	3.000	1.000	2.315
4" x 1/2"	6.130	5.315	6.130	4.630	1.750	1.500	2.315
4" x 2"	6.610	5.315	6.630	4.630	3.000	2.000	2.315
4" x 3"	7.610	5.315	7.625	4.630	3.000	3.000	2.315
5" x 1 1/2"	7.325	5.900	7.325	5.690	3.000	1.500	2.845
5" x 2"	7.833	5.900	7.830	5.690	3.000	2.000	2.845
5" x 3"	8.690	5.900	8.690	5.690	3.000	3.000	2.845
6" x 1 1/2"	8.230	6.375	8.250	6.750	3.000	1.500	3.375
6" x 2"	8.730	6.375	7.730	6.750	3.000	2.000	3.375
6" x 3"	9.790	6.375	9.750	6.750	3.000	3.000	3.375
8" x 2"	10.800	7.250	10.580	8.680	3.000	2.06	4.340
8" x 3"	11.800	7.250	11.580	8.680	3.000	3.000	4.340

For 3-1/2" duct use 4" spacers.

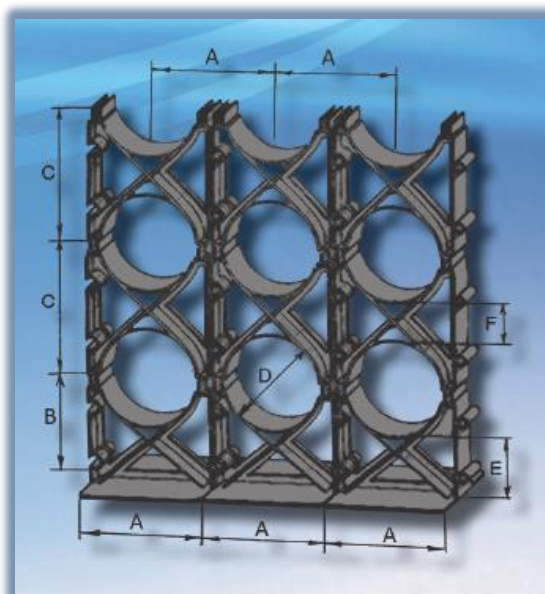
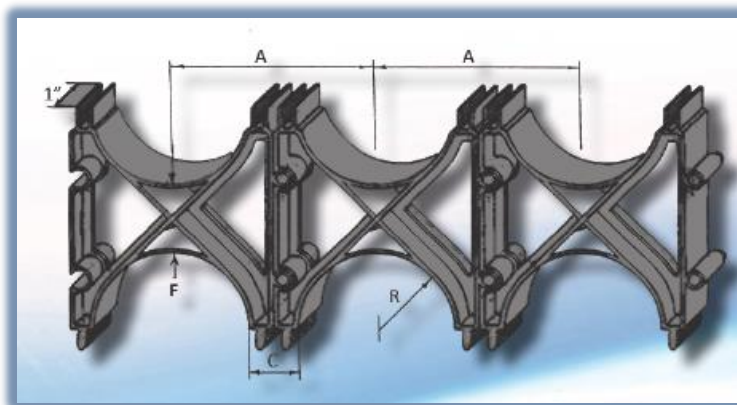

## DB & EB Duct Fittings

Price Group: GB

### 5° Coupling BXB Swedged



Part Number	Size	EACH UPC	Carton Quantity
CPXBSDDB200	2"	670648006179	20
CPXBSDDB400	4"	670648001037	15
CPXBSDDB500	5"	670648001044	8
CPXBSDDB600	6"	670648001051	4

### 5° Coupling BXS



Part Number	Size	EACH UPC	Carton Quantity
CPXSDB300	3"	670648001679	25
CPXSDB400	4"	670648001686	15
CPXSDB500	5"	670648001693	8
CPXSDB600	6"	670648001709	4

### Coupling with Center Stop



Part Number	Size	EACH UPC	Carton Quantity
CPDB300	3"	670648001716	25
CPDB400	4"	670648001723	20
CPDB500	5"	670648001730	8
CPDB600	6"	670648001747	8

### Repair Sleeve Coupling



Part Number	Size	EACH UPC	Carton Quantity
CPRPRDB200	2"	670648001877	20
CPRPRDB300	3"	670648006148	25
CPRPRDB350	3-1/2"	670648006155	20
CPRPRDB400	4"	670648006162	15
CPRPRDB400X1000	4"X10"	670648005981	15
CPRPRDB500	5"	670648001754	8
CPRPRDB600	6"	670648001761	4

### Swedge Coupling with Center Stop



Part Number	Size	EACH UPC	Carton Quantity
CPSCSDB200	2"	670648002027	20

### End Bell



Part Number	Size	EACH UPC	Carton Quantity
EBDB200	2"	670648001778	40
EBDB400	4"	670648001785	50
EBDB500	5"	670648001792	25

### Swedge Reducer SXS



Part Number	Size	EACH UPC	Carton Quantity
RSSSDB600X400	6"X4"	670648014181	4
RSSSDB600X500	6"X5"	670648014198	4

## Telephone Duct Fittings

Price Group: EC

### Sleeve Repair Couplings – No Center Stop

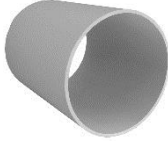

	Part Number	Size	EACH UPC	Carton Quantity
	CPRPRTD100X600	1" x 6"	670648005998	50
	CPRPRTD400X600	4" x 6"	670648006025	25
	CPRPRTD400X1200	4" x 12"	670648006001	10
	CPRPRTD400X1800	4" x 18"	670648006018	8
White	CPRPRWTD400X600	4" x 6"	670648006032	25
White – Type D Applications	CPRPRWTD400X600	4" x 6"	670648006049	25
Split Sleeve – Split 1 Side	CPSPLTTD400X600	4" x 6"	670648006070	25
	CPSPLTTD500X600	5" x 6"	670648006087	15
Split Sleeve Couplings - White	CPSPLWTD400X600	4" x 6"	670648006100	25
	CPSPLWTD400X800	4" x 8"	670648006117	15
Split Sleeve - Split 2 Sides	CPSPLT2STD400X1800	4" x 18"	670648006063	6



## William H. Harvey Company PVC Cement

Price Group: M1

### Medium P-6 Gray PVC Cement



Part Number	Size	UPC Number	Carton Quantity
018160-24	8 oz	078864181609	24 (will not break)
018170-12	16 oz	078864181708	12 (will not break)
018180-12	32 oz	078864181807	12 (will not break)

### Heavy P-12G Gray PVC Cement



Part Number	Size	UPC Number	Carton Quantity
018260-24	8 oz	078864182606	24 (will not break)
018270-12	16 oz	078864182705	12 (will not break)
018280-12	32 oz	078864182804	12 (will not break)

### All Temp All Weather Medium Clear PVC Solvent Cement



Part Number	Size	UPC Number	Carton Quantity
018320-12	16 oz	078864183207	12 (will not break)
018330-12	32 oz	078864183306	12 (will not break)

### Clear Primer



Part Number	Size	UPC Number	Carton Quantity
019020-12	16 oz	078864190205	12 (will not break)
019030-12	32 oz	078864190304	12 (will not break)

Please contact the William H. Harvey Company for product questions and technical support regarding the cements and primers.

Customer Service  
800-321-9532  
Fax 800-321-9535

Technical Questions  
E-mail [harveytechnical@oateyscs.com](mailto:harveytechnical@oateyscs.com)

## Conduit Installation Instructions – Cementing Joints

1. Prime Conduit's PVC conduit in sizes 1/2" through 1-1/2" should be cut square using a fine tooth handsaw or rotating pipe cutter and then deburred. A miter box or similar saw guide should be utilized to keep the material steady for the larger sizes 2" through 6". After cutting and deburring, wipe ends clean of dust, dirt and shavings.



2. Be sure that conduit end is clean and dry. Apply coat of solvent cement to the end of conduit, the length of the socket to be attached. Prime Conduit offers a variety of Harvey Solvent Cement products. The application situation will determine the type of solvent cement needed.



3. Push conduit firmly into fitting while rotating conduit slightly about one-quarter turn to spread cement evenly. Allow joint to set per the solvent cement manufacturer's recommendations.

## Split Duct

Prime Conduit Split Duct is the fast and easy way to repair broken ductwork without the costly cutting and resplicing of your conductors.

Our unique tongue-and-groove design leads the industry in providing a strong, rigid solution for duct repair situations.

The interlocking design allows the split duct sections to be staggered and butted together. Joints may be sealed with tape and reinforced with plastic or metallic straps to produce a rigid, stable unit.

Manufactured from a compound designed specifically for power and telecommunications applications, Prime Conduit Split Duct exhibits superior impact strength.

Available in 2" through 6" diameters, this product line also contains couplings and sweeps necessary to complete the system.

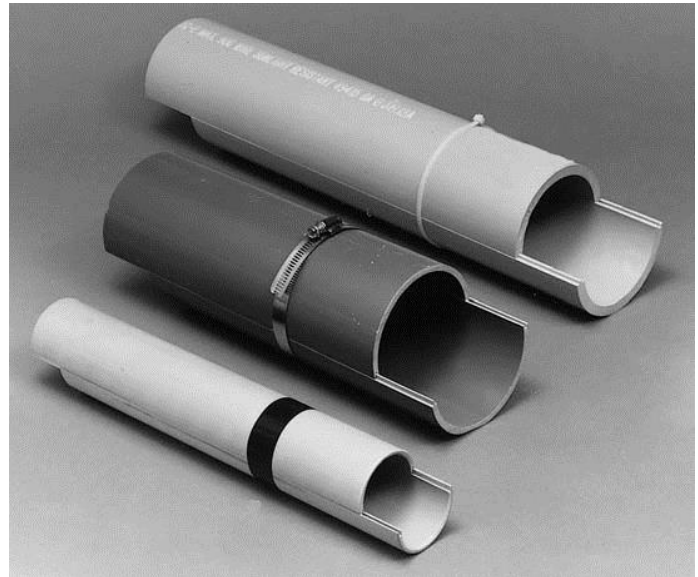

*The fast and easy method of installing duct around existing cable for repair and temporary installations.*

### Recommended Installation Procedure

1. Place one 10-foot Split Duct section under cable.
2. In order to stagger joints, saw another section in half (about 5 feet long).
3. Place 5-foot section over cable and snap the two sections together.
4. Place strap about one foot from the end and another strap about a foot from the joint where the ends of the top sections will butt.
5. Place another 10-foot Split Duct section over the open half of the bottom section, butt the ends tightly together and snap the sections together.
6. Place a length of tape around both sections of the Split Duct to cover the butted joint.
7. Place a strap about one foot beyond the taped joint.
8. Lay another length of Split Duct underneath cable, butt together, tape the butted joint and strap one foot on each side of the joint.
9. Repeat procedure.

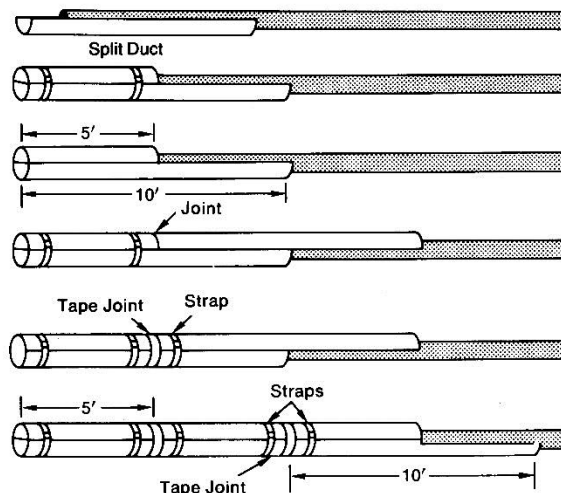

## Split Duct

### Split Duct



Price Group: U1

Part Number	Size	Type	UPC Number	Carton Quantity	Std. Ctn. Wt. (lbs.)	OD
49011SD-010	2"	Schedule 40	670648011470	700	561	2.375
49012SD-010	2-1/2"	Schedule 40	670648135770	460	562	2.875
49013SD-010	3"	Schedule 40	670648011487	500	830	3.500
49014SD-010	3-1/2"	Schedule 40	670648036503	290	560	4.000
49015SD-010	4"	Schedule 40	670648011494	290	680	4.500
49016SD-010	5"	Schedule 40	670648011500	230	718	5.563
49017SD-010	6"	Schedule 40	670648011517	130	523	6.625
49411SD-010	2"	Schedule 80	670648211283	700	702	2.375
49415SD-010	4"	Schedule 80	670648011456	290	890	4.500
68515SD-010	4"	Telephone Type C	670648011333	320	624	4.350

### Schedule 40 & 80 Split Sleeve Couplings No Center Stop



CPSPLT1S – split 1 side  
CPSPLT2S – split 2 sides

Price Group: U2

Part Number	Size	UPC Number	Carton Quantity	Diameter x Length	Std. Ctn. Wt. (lbs.)
CPSPLT1S200X600	2"	670648000351	25	2" X 6"	4
CPSPLT1S250X700	2-1/2"	670648000368	25	2-1/2" X 7"	21
CPSPLT1S300X700	3"	670648000375	25	3" X 7"	19
CPSPLT1S350X800	3-1/2"	670648000511	25	3-1/2" X 8"	40
CPSPLT1S400X800	4"	670648000399	15	4" X 8"	13
CPSPLT1S500X400	5"	670648000443	30	5" X 4"	22
CPSPLT1S500X800	5"	670648000450	15	5" X 8"	22
CPSPLT1S500X900	5"	670648000467	8	5" X 9"	14
CPSPLT1S600X1000	6"	670648000474	4	6" X 10"	9
CPSPLT2S300X650	3"	670648000481	25	3" X 6-1/2"	11
CPSPLT2S400X600	4"	670648000993	25	4" X 6"	18

### Split Sleeve Couplings – For joining Split Duct to existing Duct

#### Telephone C Duct Split Sleeve Couplings White No Center Stop

Split 1 Side

Price Group: EC

Part Number	Size	UPC Number	Carton Quantity	Diameter x Length	Std. Ctn. Wt. (lbs.)
CPSPLTWT400X600	4"	670648006100	25	4" x 6"	19
CPSPLTWT400X800	4"	670648006117	15	4" x 8"	22

### Split Sleeve Sweeps



Price Group: U1

Two 45° elbows may be segmented for 90°.

Part Number	Angle	Nom. Size	UPC Number	Carton Quantity	Std. Ctn. Wt. (lbs.)
UA7DJSD	45°	2"	670648339222	1	1.4
UA7FJSD	45°	2"	670648002553	1	2.1
UA7FLSD	45°	3"	670648339321	1	4.7
UA7HJSD	45°	2"	670648339345	1	2.7
UA7HLSD	45°	3"	670648339352	1	6.1
UA7IJSD	45°	2"	670648339390	1	3.2
UA7ILSD	45°	3"	670648339413	1	7.2
UA7INSD	45°	4"	670648339437	1	10.2
UA5INSD	22½°	4"	670648338560	1	6.1
UA3IJSD	11¼°	2"	670648337969	1	1
UA3ILSD	11¼°	3"	670648337976	1	3.6
UA3INSD	11¼°	4"	670648337983	1	5.1

## Split Kits

Prime Conduit Split Kits are specifically designed to make Schedule 40 conduit and Type C Telephone Duct repairs faster and easier! Damaged conduit can be repaired without disturbing the installed wire/cable system. Prime Conduit Split Kits come in handy 2 feet lengths with 7 inch split couplings on each end. UV-resistant for outdoor use, Split Kits feature the same durable tongue-and-groove design as Prime Conduit's Split Duct product.

Split Kits are manufactured from extra rugged PVC material. The unique design maintains the same physical performance and dimensional characteristics as the PVC pipe it is repairing! No other repair product can make this offer! The reason is in the interlocking/ tongue-and-groove design that holds the true dimensions of the product, both I.D. and O.D., while maintaining the pipe's physical performance characteristics too.

### Prime Conduit® Split Kits... Conduit Repairs made Faster and Easier.



#### Features:

- Interlocking/tongue-and-groove design to assure dimensional pipe characteristics.
- Convenient and handy for easy handling, transport and storage.
- 2 ft lengths for fast/easy conduit repairs. Eliminates the need of cutting standard 10ft. lengths to size. Get off the jobsite FASTER!
- Two 7" split couplings for a secure fit. Allows the product to be coupled together for longer repairs. Solvent cementable = water resistant.
- Available in two wall types – Schedule 40 (Sizes 2"through 6") and Type C (4")
- Manufactured from extra rugged PVC – Lightweight, solvent cementable and compatible with all standard pipe fittings.

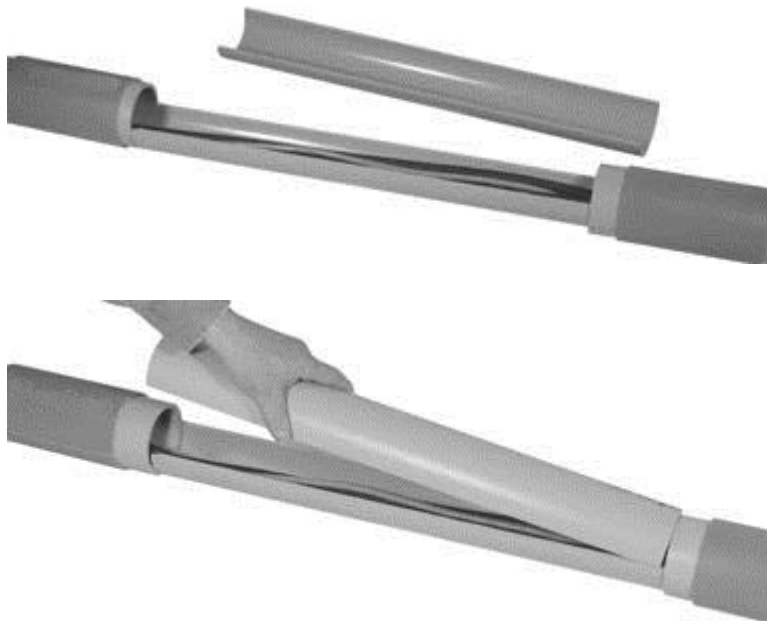



## Split Kits

Price Group: U1

Part Number	Size	Wall Type	UPC Number	Carton Quantity	Std. Ctn. Wt. (lbs.)
SK4020	2"	Schedule 40	670648190083	10	24.3
SK4025	2-1/2"	Schedule 40	670648190090	10	49.2
SK4030	3"	Schedule 40	670648190106	8	43.6
SK4040	4"	Schedule 40	670648190113	5	40.5
SK4050	5"	Schedule 40	670648190120	3	34.6
SK4060	6"	Schedule 40	670648190137	2	36.4
SKC40	4"	Type C	670648190144	5	36.2

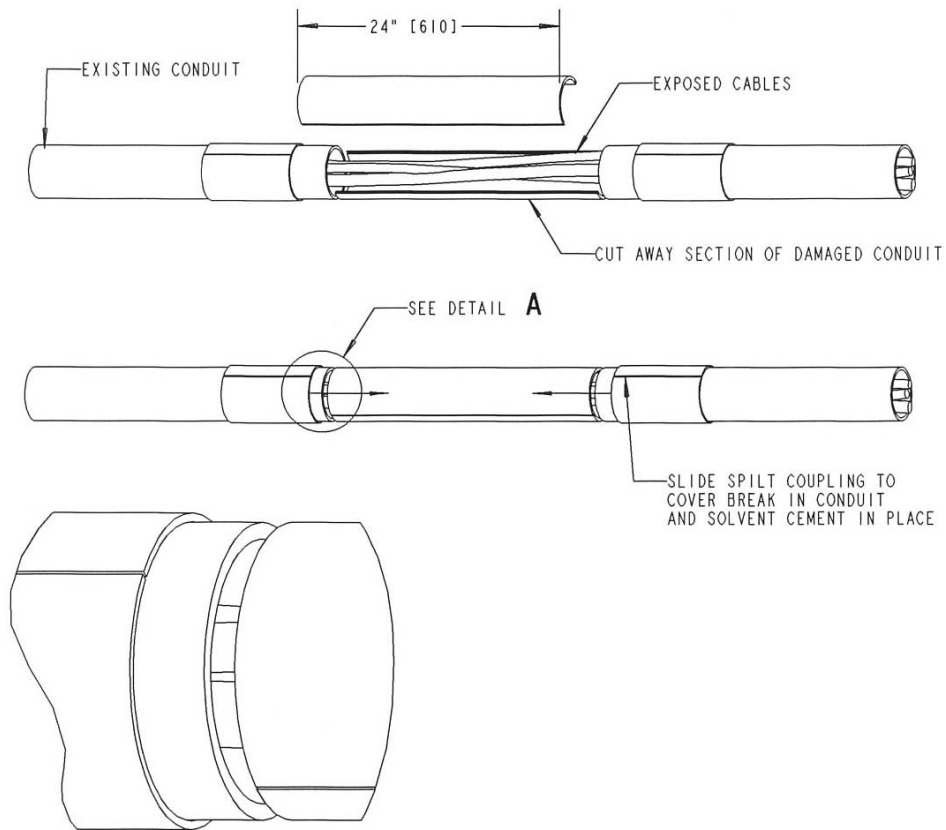

DETAIL **A**  
SCALE 0.500